



Joseph  
Freund

portfolio

# contents

- 1 artist residence in flood zone  
net-zero, flood adaptable commercial & residential (M.Arch, team of 3)
- 2 corning apartments  
efficient rural community living (M.Arch, self)
- 3 boston symphony center  
experimental music, public engagement (M.Arch, 1 partner)
- 4 market one rehab  
office space planning, connection to context, solar canopy (consult, self)
- 5 cambodian sustainable housing  
housing for tropical, flood-prone regions (competition, self)
- 6 cool school - mongolia  
school to weather the mongolian elements (competition, self)
- 7 mountain adaptation guide for bogotá, colombia  
building guide for new urban migrants (M.Arch, self)
- 8 residential consulting  
lake house, b&b, grain bin residences (consult, work with architect)
- 9 eWalk - electric personal transport vehicle  
mobile alternative for campus safety & security (capstone, 6 member team)
- 10 transporation system  
automatic delivery concept (consult, work with architect)



-48,657	132,110	255,117	-223,884	-176,511	-159,687	-65,704
-55,511	111,161	216,664	-221,884	-177,458	-125,909	-68,564
-54,840	113,927	216,664	-225,781	-178,461	-119,252	-76,235
-59,275	114,005	217,008	-223,884	-180,209	-135,787	-76,127
-62,861	114,852	216,905	-223,884	-181,246	-137,881	-80,238
-81,193	-116,844	-261,764	-223,884	-185,434	-81,800	227,017
244,129	76,129	217,044	-189,876	-60,209	109,995	345,517
392,299	178,661	-49,961	42,467	161,112	286,844	413,284
513,000	275,437	20,710	89,249	268,109	452,212	498,277
550,160	388,796	71,854	151,414	188,323	521,191	417,255
500,000	375,000	47,431	166,665	397,718	502,779	479,487
610,278	419,189	31,274	99,870	411,888	635,188	664,211
178,761	492,861	43,906	112,464	179,461	569,110	645,628
537,889	848,921	65,381	155,115	338,642	520,355	600,766
485,790	218,108	11,427	159,760	266,428	418,792	159,461
255,445	3,281	189,688	-1,757	96,549	207,291	447,813
13,848	-78,016	-242,805	-201,136	-41,670	66,450	117,492
-13,110	-65,540	-248,467	-203,709	-105,078	-40,386	61,284
-24,961	-93,169	-250,382	-206,817	-159,464	-45,993	-11,410
11,610	-97,904	-254,170	-209,458	-162,365	-93,169	-42,620
-12,217	-99,709	-255,117	-210,665	-165,546	-99,709	-49,116
-39,187	-103,493	-257,011	-210,870	-168,914	-103,493	-51,498
-44,446	-107,817	-257,011	-213,446	-171,278	-107,817	-51,227
-48,617	-108,410	-260,709	-218,287	-175,564	-111,161	-60,022

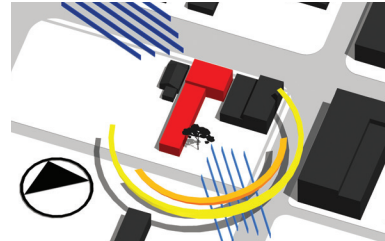
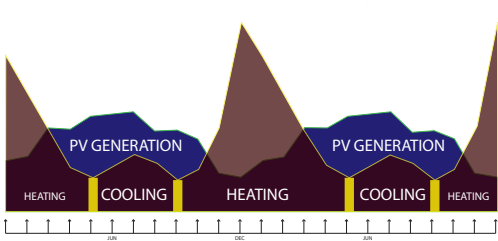

# artist residence in flood zone

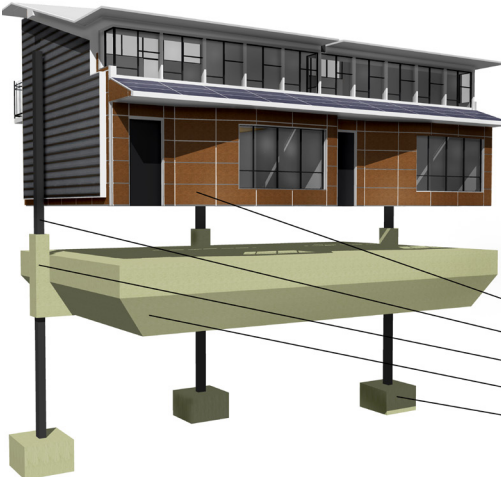

- FLOOD MITIGATION SYSTEM**
- LIGHT WEIGHT CONSTRUCTION
  - VERTICAL GUIDE COLUMNS
  - GUIDE COLUMN SLEEVES
  - CONC. COVERED FOAM BASE
  - IN-GROUND CONC. FOOTINGS

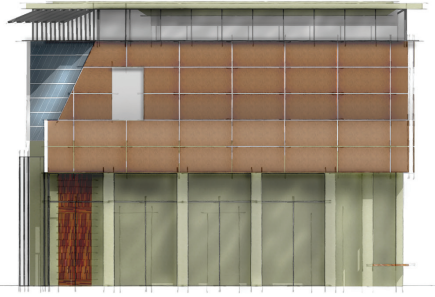



# corning apartments

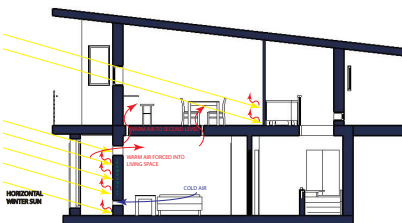

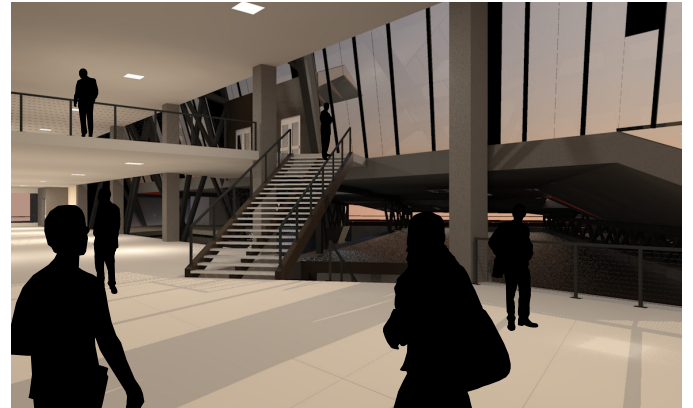
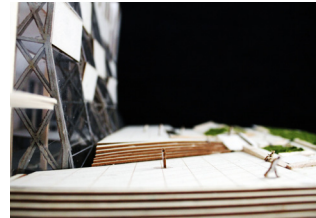
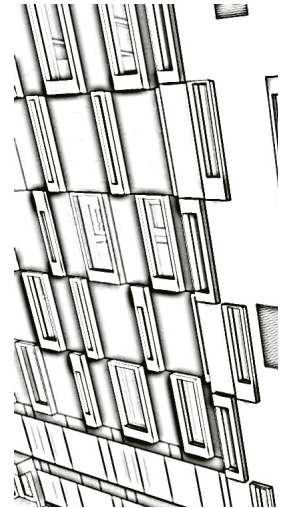
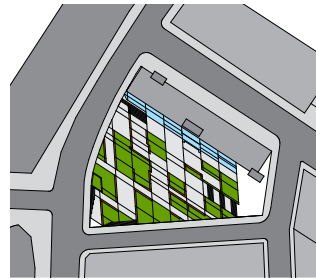

# boston symphony center

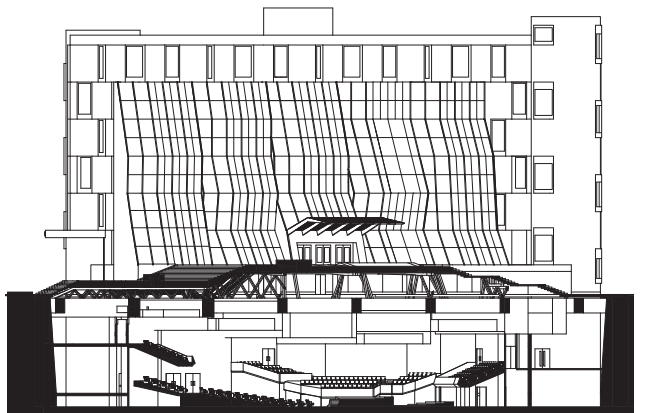
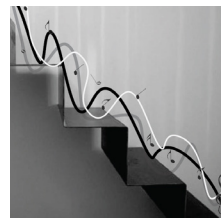
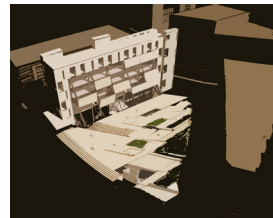
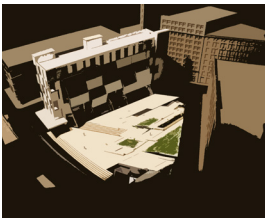
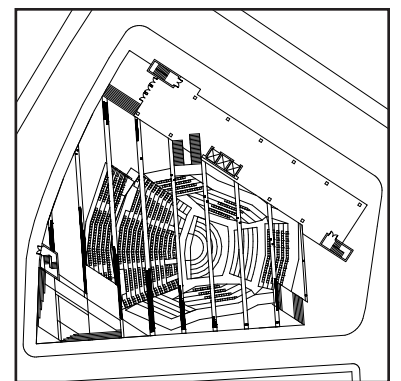
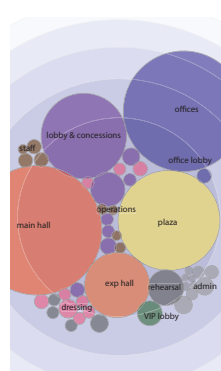
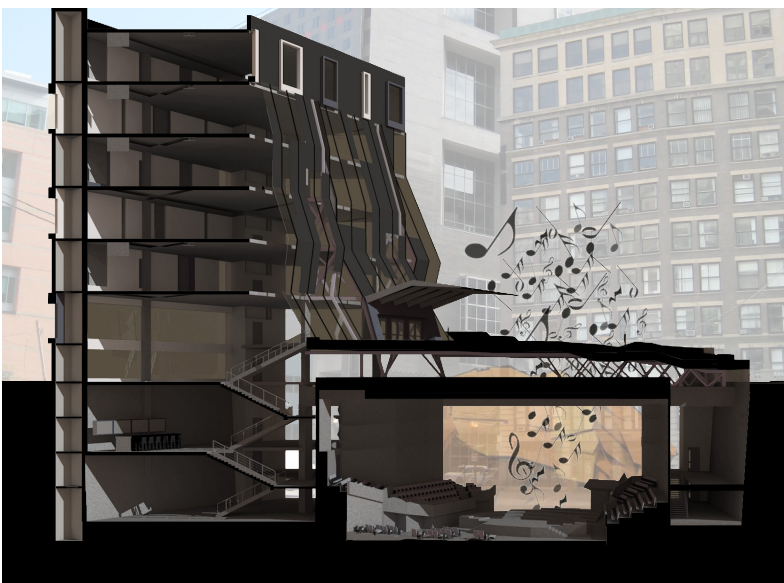

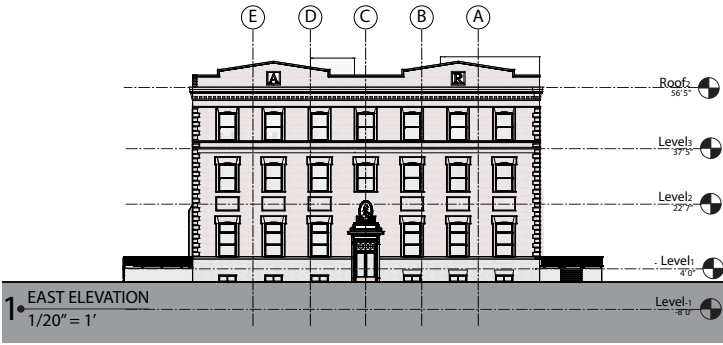

# market one rehabilitation

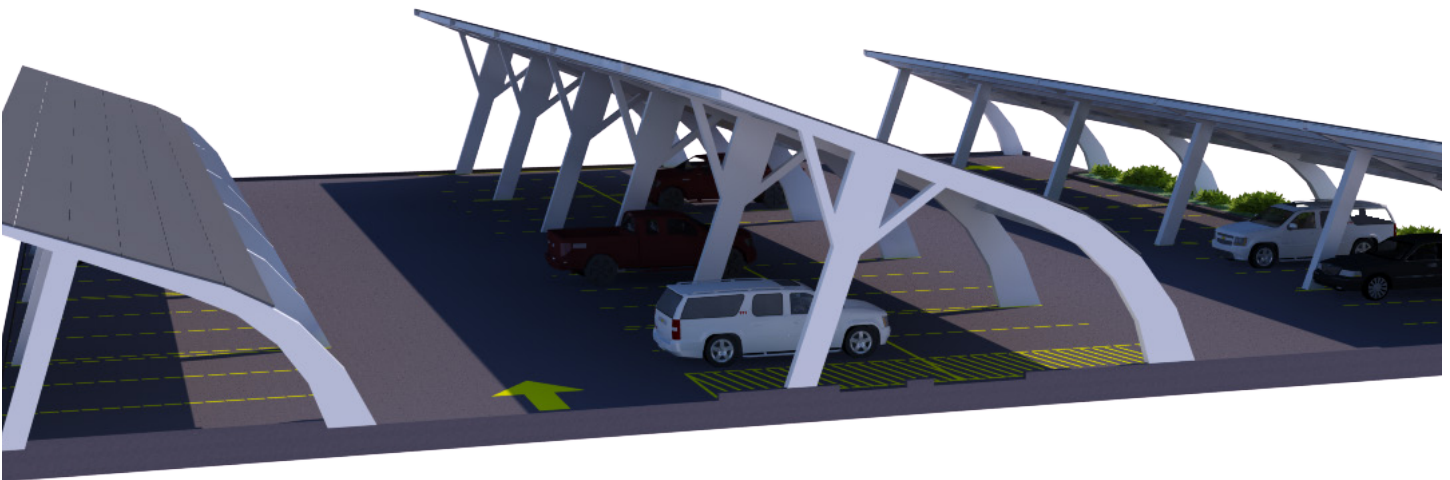
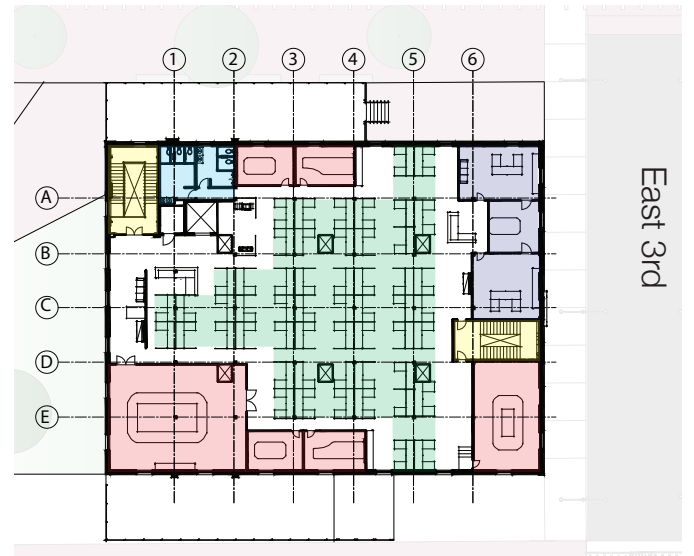
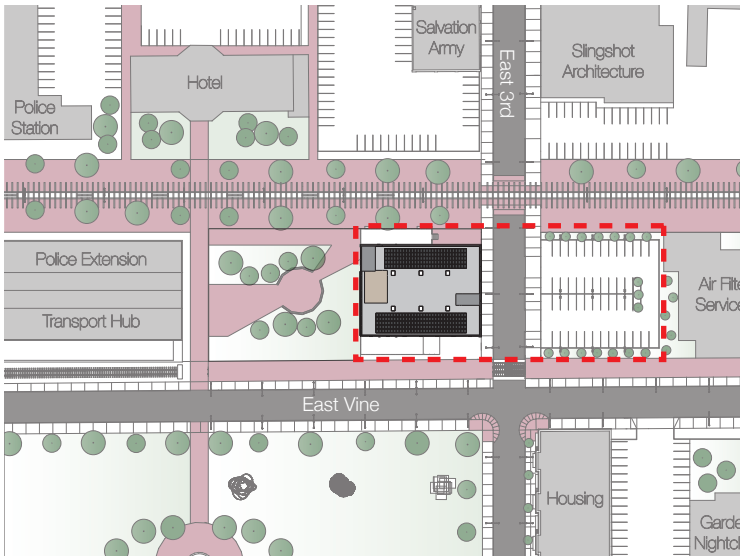

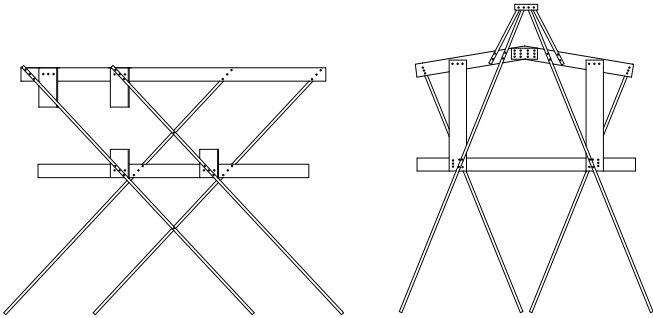
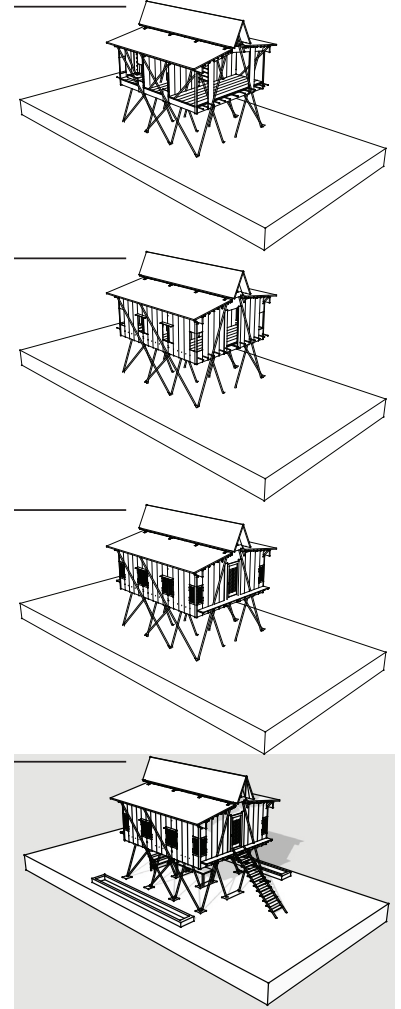

# sustainable housing-cambodia

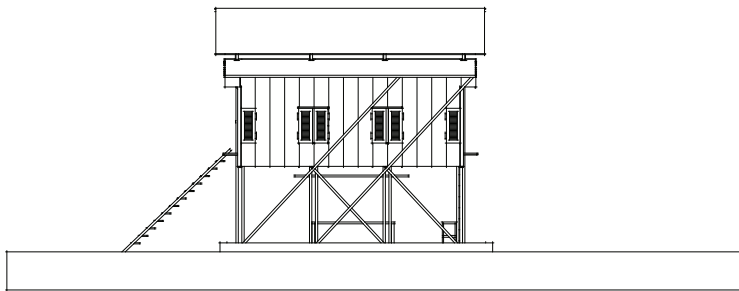

East Elevation

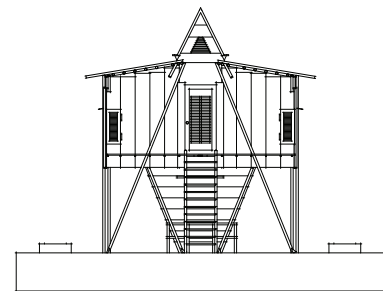

Front Elevation

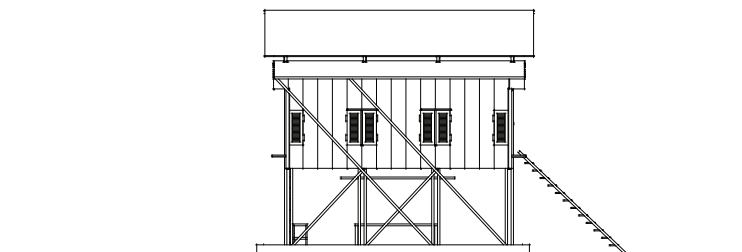

West Elevation

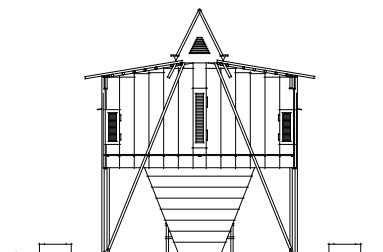

Back Elevation

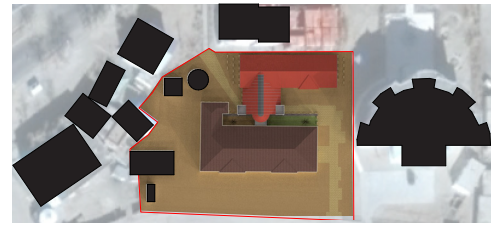
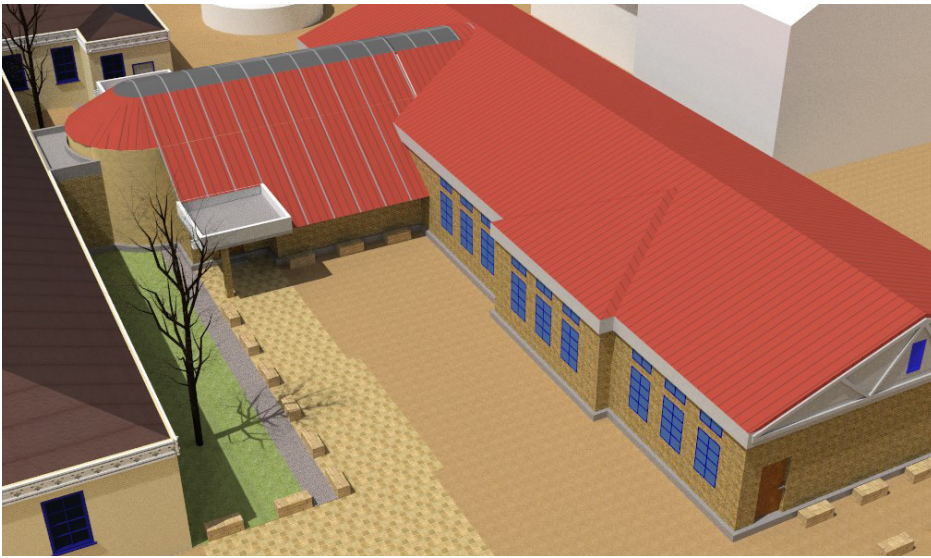

cool school-mongolia

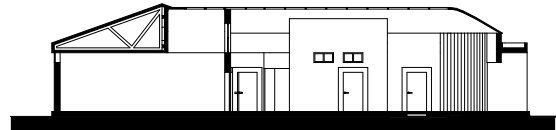
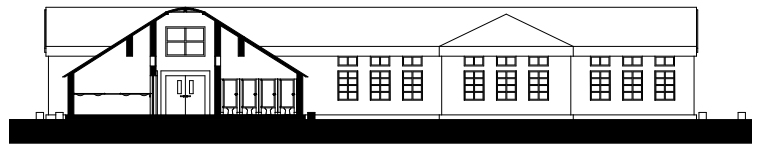
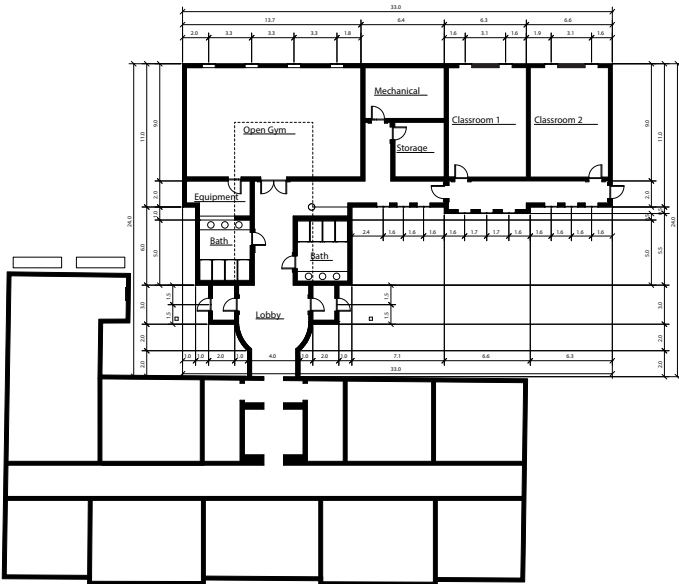



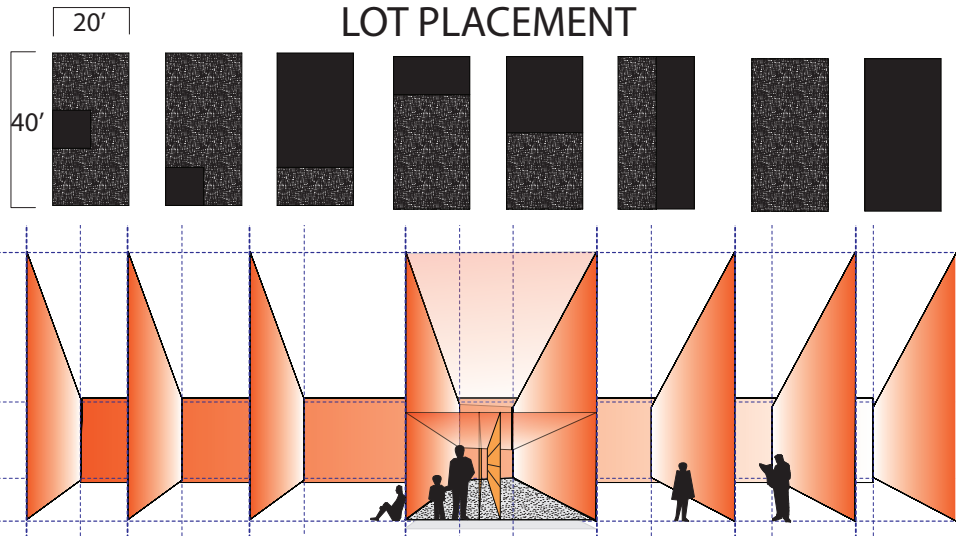
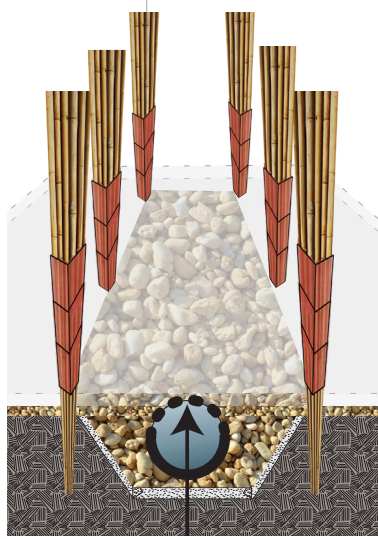
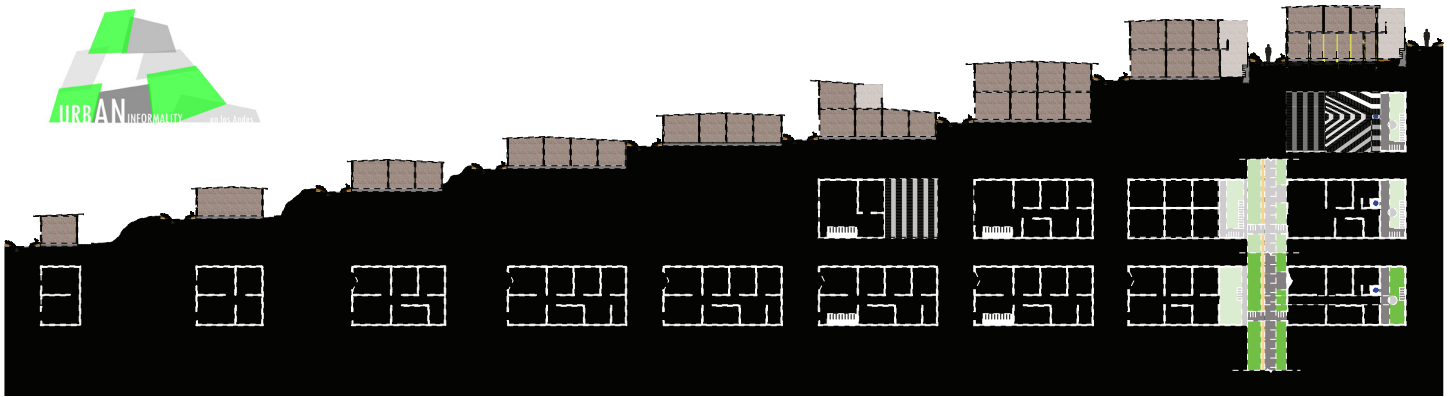

# mountain adaptation guide for bogotá, colombia

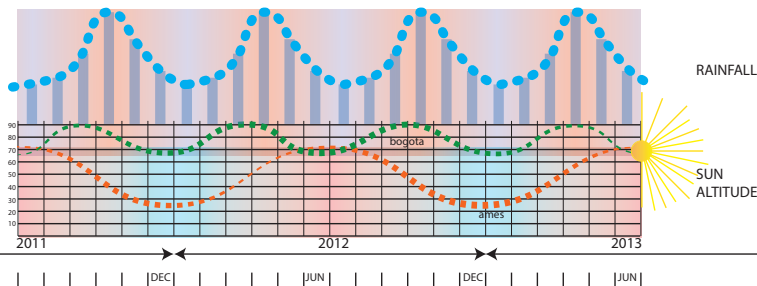
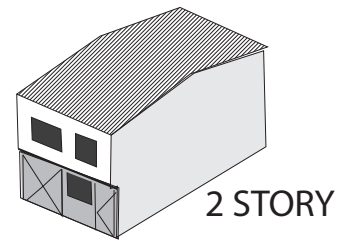
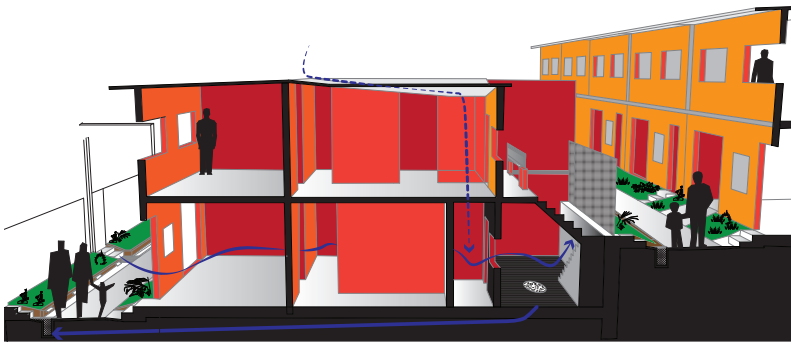

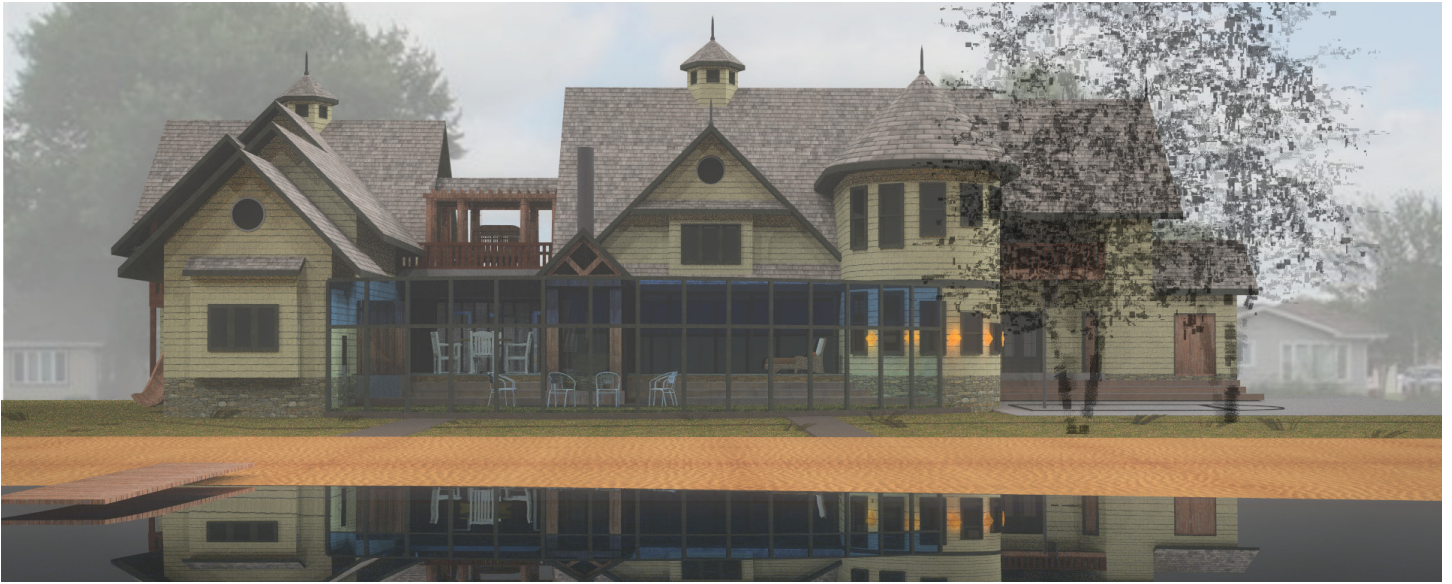

residential consulting

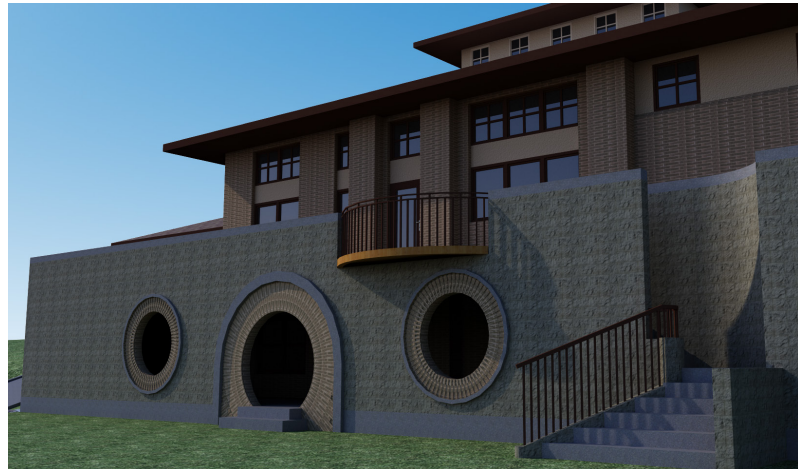
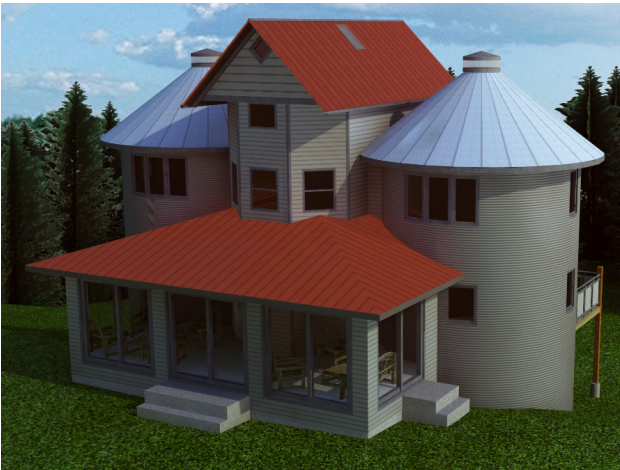



# eWalk - electric personal transport vehicle

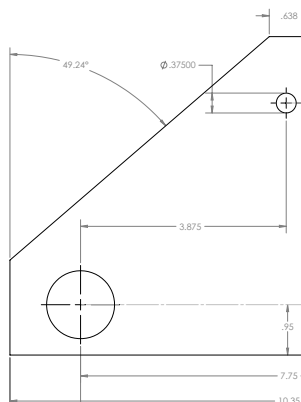
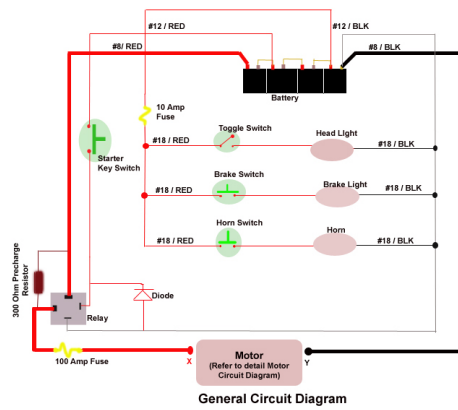
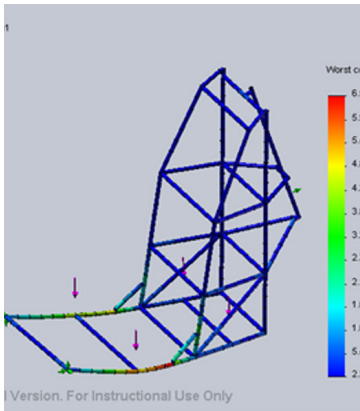

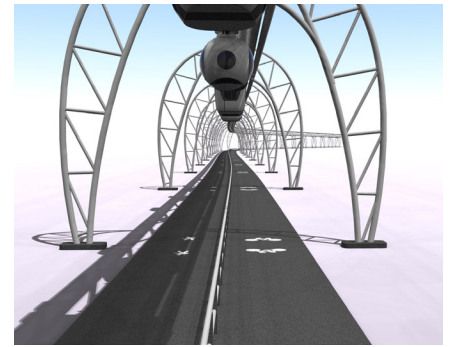
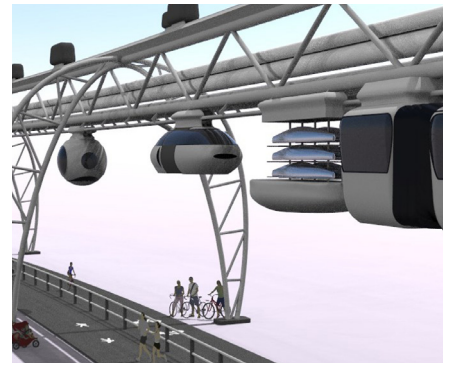

# transportation system

